



INSPIRON 3847



[Views](#)

[Specifications](#)

© 2014 Dell Inc.

Trademarks used in this text: Dell™, the DELL logo, and Inspiron™ are trademarks of Dell Inc. Intel® is a registered trademark and Celeron™ is a trademark of Intel Corporation in the U.S. and other countries. Bluetooth® is a registered trademark owned by Bluetooth SIG, Inc. and is used by Dell under license.

2014 - 06 Rev. A01

Regulatory model: D16M | Type: D16M001

Computer model: Inspiron 3847

NOTE: The images in this document may differ from your computer depending on the configuration you ordered.



Front



Front



Back



Back panel

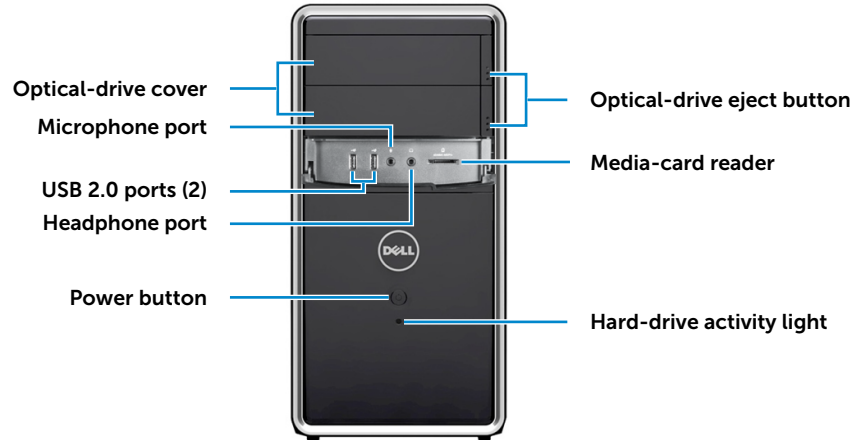

Optical-drive cover

Covers the optical drives.

Microphone port

Connect an external microphone to provide sound input.

USB 2.0 ports (2)

Connect peripherals such as storage devices, printers, and so on. Provides data transfer speeds up to 480 Mbps.

Headphone port

Connect a headphone, a headset (headphone and microphone combo), or speakers.

Power button

Press to turn on the computer if it is turned off or in Sleep state.

Press to put the computer in Sleep state if it is turned on.

Press and hold for 10 seconds to force shut-down the computer.

NOTE: You can customize the power-button behaviour in Power Options. For more information, see *Me and My Dell* at dell.com/support.

Optical-drive eject button

Press to open or close the optical drive tray.

Media-card reader

Reads from and writes to media cards.

Hard-drive activity light

Turns on when the computer reads from or writes to the hard drive.



Front



Back



Back panel

Back

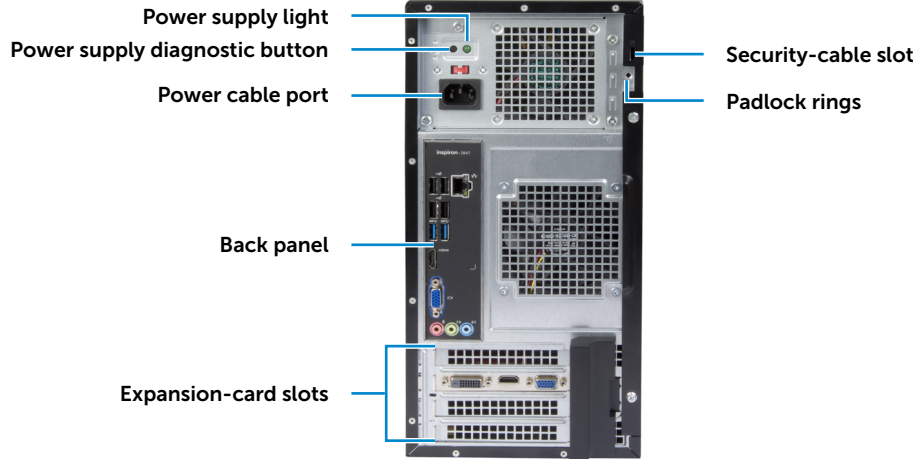

Power supply light

Indicates power availability of the power supply.

Power supply diagnostic button

Press to turn on the power supply light.

Power cable port

Connect a power cable to provide power to your computer.

Back panel

Connect USB, audio, video, and other devices.

Expansion-card slots

Provide access to connectors on any installed PCI Express cards.

Security-cable slot

Connect a security cable to prevent unauthorized movement of your computer.

Padlock rings

Attach a standard padlock to prevent unauthorized access to the interior of your computer.



Back panel



Front



Back



Back panel

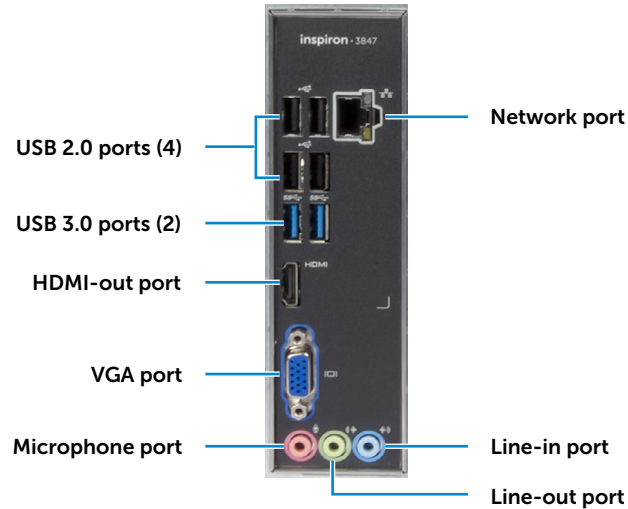

USB 2.0 ports (4)

Connect peripherals, such as storage devices, printers, and so on. Provides data transfer speeds up to 480 Mbps.

USB 3.0 ports (2)

Connect peripherals such as storage devices, printers, and so on. Provides data transfer speeds up to 5 Gbps.

HDMI-out port

Connect to HDMI-out enabled devices. Provides video and audio output.

VGA port

Connect an external display or a projector.

Microphone port

Connect an external microphone to provide sound input.

Network port

Connect an Ethernet (RJ45) cable from a router or a broadband modem for network or internet access.

The two lights next to the connector indicate the connectivity status and network activity.

Line-in port

Connect recording or playback devices such as a microphone or CD player.

Line-out port

Connect speakers.



Specifications

Dimensions and Weight

| | |
|------------------|---------------------|
| Height | 368.3 mm (14.50 in) |
| Width | 177.8 mm (7 in) |
| Depth | 431.8 mm (17 in) |
| Weight (maximum) | 7.9 kg (17.41 lb) |

NOTE: The weight of your desktop varies depending on the configuration ordered and the manufacturing variability.



Dimensions and Weight



System Information



Memory



Ports and Connectors



Communications



Video



Audio



Storage



Media-card reader



Power Ratings



Computer Environment



Specifications

System Information

| | |
|----------------|---|
| Computer model | Inspiron 3847 |
| Processor | <ul style="list-style-type: none">• Intel Celeron• Intel Pentium Dual Core• Intel Dual Core i3 (4th Generation)• Intel Quad Core i5 (4th Generation)• Intel Quad Core i7 (4th Generation) |
| L3 cache | Up to 8 MB |
| Chipset | Intel H81 |



Dimensions and Weight



System Information



Memory



Ports and Connectors



Communications



Video



Audio



Storage



Media-card reader



Power Ratings



Computer Environment



Specifications

Memory

| | |
|--------------------------|---|
| Connector | Two internally-accessible DDR3 DIMM sockets |
| Type | DDR3 |
| Speed | 1600 MHz |
| Configurations supported | 2 GB, 4 GB, 8 GB, 12 GB, and 16 GB |



Dimensions and Weight



System Information



Memory



Ports and Connectors



Communications



Video



Audio



Storage



Media-card reader



Power Ratings



Computer Environment



Specifications

Ports and Connectors

Back Panel Ports:

| | |
|---------|--|
| Network | One RJ45 port |
| USB | <ul style="list-style-type: none">• Four USB 2.0 ports• Two USB 3.0 ports |
| Audio | <ul style="list-style-type: none">• One microphone port• One line-out port• One line-in port |
| Video | <ul style="list-style-type: none">• One HDMI-out port• One VGA port |

Front Panel Ports:

| | |
|-------------------|--|
| Media Card Reader | One 8-in-1 card slot |
| USB | Two USB 2.0 ports |
| Audio | <ul style="list-style-type: none">• One microphone port• One headphone port |

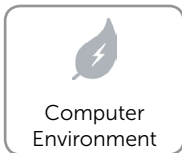
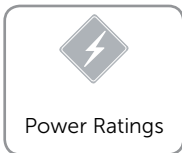
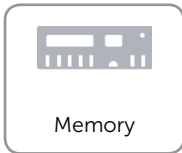
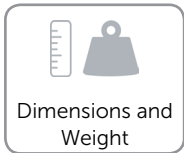



Specifications

Communications

| | |
|----------|---|
| Ethernet | 10/100/1000 Mbps Ethernet controller integrated on system board |
| Wireless | Dell Wireless-N 1705 and Bluetooth 4.0 |



Dimensions and Weight



System Information



Memory



Ports and Connectors



Communications



Video



Audio



Storage



Media-card reader



Power Ratings



Computer Environment



Specifications

Video

Controller:

Integrated

- Intel HD graphics
- Intel HD graphics 4400/4600

Discrete

- NVIDIA GeForce GT 625
- NVIDIA GeForce GT 635
- NVIDIA GeForce GT 705

Memory:

Integrated

Shared system memory

Discrete

1024 MB

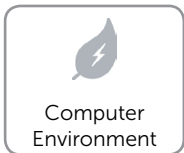
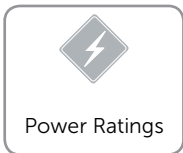
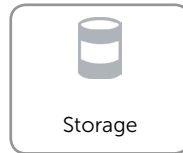
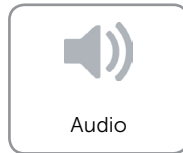
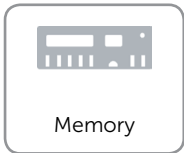
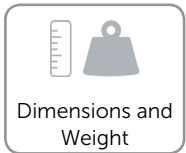



Specifications

Audio

Controller

Realtek Audio Codec ALC662VD

Type

Intel 5.1 channel HD Audio (integrated)



Dimensions and Weight



System Information



Memory



Ports and Connectors



Communications



Video



Audio



Storage



Media-card reader



Power Ratings



Computer Environment



Specifications

Storage

| | |
|-----------------------|--|
| Externally accessible | Two 5.25-inch drive bay for a Blu-ray Disc combo (optional), Blu-ray Disc writer (optional), or DVD+/-RW |
| Internally accessible | Two 3.5-inch drive bay for SATA hard drives (includes hybrid) |



Dimensions and Weight



System Information



Memory



Ports and Connectors



Communications



Video



Audio



Storage



Media-card reader



Power Ratings



Computer Environment



Specifications

Media-card reader

| | |
|-----------------|--|
| Type | One 8-in-1 slot |
| Cards supported | <ul style="list-style-type: none">• Secure Digital (SD)• SD Extended Capacity (SDXC)• High Capacity SD (SDHC)• Memory Stick (MS)• Memory Stick PRO (MS PRO)• MultiMedia Card (MMC)• MultiMedia Card plus (MMC+)• xD-Picture Card (XD) |



Dimensions and Weight



System Information



Memory



Ports and Connectors



Communications



Video



Audio



Storage



Media-card reader



Power Ratings



Computer Environment



Specifications

Power Ratings

| | |
|-------------------------|---|
| Input voltage | <ul style="list-style-type: none">• 100 VAC-127 VAC• 200 VAC-240 VAC |
| Input frequency | 50 Hz–60 Hz |
| Input current (maximum) | 9.0 A/4.5 A |

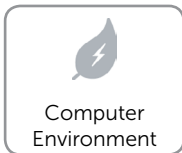
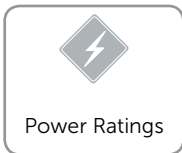
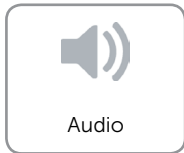
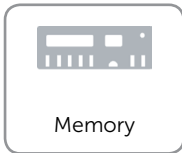
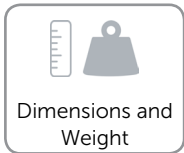



Specifications

Computer Environment

| Airborne contaminant level | G2 or lower as defined by ISA-S71.04-1985 | |
|-----------------------------|--|---|
| Relative humidity (maximum) | 20% to 80% (noncondensing) | |
| | Operating | Storage |
| Temperature range | 10 °C to 35 °C (50 °F to 95 °F) | -40 °C to 65 °C (-40 °F to 149 °F) |
| Vibration (maximum)* | 0.25 GRMS | 2.20 GRMS |
| Shock (maximum)† | 40 G for 2 ms with a change in velocity of 20 in/s (51 cm/s) | 50 G for 26 ms with a change in velocity of 320 in/s (813 cm/s) |
| Altitude (maximum) | -15.2 m to 3048 m (-50 ft to 10,000 ft) | -15.2 m to 10,668 m (-50 ft to 35,000 ft) |

* Measured using a random vibration spectrum that simulates user environment.

† Measured with hard drive in operating status and a 2-ms half-sine pulse for operating. Also measured with hard drive in head-parked position and a 2-ms half-sine pulse for storage.

